

Low Noise, Low Quiescent Current, 150mA Linear Regulator with Noise Bypass

FEATURES

- Very Low Noise, $25 \mu\text{V}_{\text{RMS}}$ @ $f=10\sim 100\text{kHz}$.
- Very Low Quiescent Current, $35 \mu\text{A}$.
- Very Low Dropout Voltage, 90mV @ 50mA .
- Active Low Shutdown Control.
- Short Circuit and Thermal Protection.
- 1.5V, 1.8V, 2.0V, 2.5V, 2.8V, 2.85V, 2.9V, 3.0V, 3.3V Output Voltage.
- Available in $\pm 2\%$ Output Tolerance.
- Low Profile Package: SOT-23-5

APPLICATIONS

- Cellular Telephones.
- Pagers.
- Personal Communication Equipment.
- Cordless Telephones.
- Portable Instrumentation.
- Portable Consumer Equipment.
- Radio Control Systems.
- Low Voltage Systems.
- Battery Powered Systems

DESCRIPTION

AIC1742 is a low noise, low dropout linear regulator, and is housed in a small SOT-23-5 package. The device is in the "ON" state when the SHDN pin is set to logic high level. A low dropout voltage of 90mV at 50mA load current is performed. It offers high precision output voltage of $\pm 2\%$. The quality of low quiescent current and low dropout voltage makes this device ideal for battery power applications. The internal reverse bias protection eliminates the requirement for a reverse voltage protection diode. The high ripple rejection and low noise of AIC1742 provide enhanced performance for critical applications. The noise bypass pin can be connected an external capacitor to reduce the output noise level.

TYPICAL APPLICATION CIRCUIT

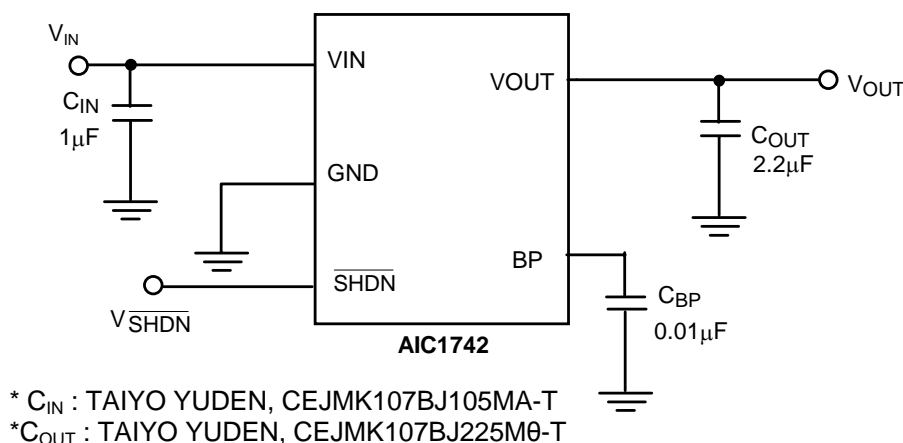

Low Noise Low Dropout Linear Regulator

ORDERING INFORMATION

AIC1742-XXX XXX XX

PACKING TYPE
 TR: TAPE & REEL
 BG: BAG

C: COMMERCIAL
 ACV: SOT-23-5
 BCV: SOT-23-5

P: LEAD FREE COMMERCIAL
 APV: SOT-23-5
 BPV: SOT-23-5

G: GREE PACKAGE
 AGV: SOT-23-5
 BGV: SOT-23-5

OUTPUT VOLTAGE

- 15: 1.5V
- 18: 1.8V
- 20: 2.0V
- 25: 2.5V
- 28: 2.8V
- 285: 2.85V
- 29: 2.9V
- 30: 3.0V
- 33: 3.3V

(Of a unit of 0.1V within the voltage range from 1.5V to 3.3V, additional voltage versions for this product line may be available on demand with prior consultation with AIC.)

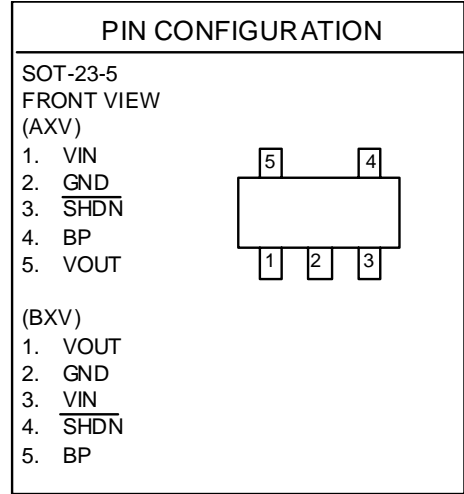

• SOT-23-5 Marking

Part No.	ACV	APV	AGV	Part No.	BCV	BPV	BGV
AIC1742-15AXV	ER15	ER15P	ER15G	AIC1742-15BXV	ES15	ES15P	ES15G
AIC1742-18AXV	ER18	ER18P	ER18G	AIC1742-18BXV	ES18	ES18P	ES18G
AIC1742-20AXV	ER20	ER20P	ER20G	AIC1742-20BXV	ES20	ES20P	ES20G
AIC1742-25AXV	ER25	ER25P	ER25G	AIC1742-25BXV	ES25	ES25P	ES25G
AIC1742-28AXV	ER28	ER28P	ER28G	AIC1742-28BXV	ES28	ES28P	ES28G
AIC1742-285AXV	ER2J	ER2JP	ER2JG	AIC1742-285BXV	ES2J	ES2JP	ES2JG
AIC1742-29AXV	ER29	ER29P	ER29G	AIC1742-29BXV	ES29	ES29P	ES29G
AIC1742-30AXV	ER30	ER30P	ER30G	AIC1742-30BXV	ES30	ES30P	ES30G
AIC1742-33AXV	ER33	ER33P	ER33G	AIC1742-33BXV	ES33	ES33P	ES33G

■ ABSOLUTE MAXIMUM RATINGS

Supply Voltage	9V
Shutdown Terminal Voltage9V
Power Dissipation	500mW
Operating Temperature Range	-40°C~85°C
Maximum Junction Temperature	125°C
Storage Temperature Range	-65°C~150°C
Lead Temperature (Soldering, 10 sec)	260°C
Thermal Resistance Junction to Case	130°C/W
Thermal Resistance Junction to Ambient	220°C/W

(Assume no ambient airflow, no heatsink)

Absolute Maximum Ratings are those values beyond which the life of a device may be impaired.

■ TEST CIRCUIT

Refer to TYPICAL APPLICATION CIRCUIT

■ ELECTRICAL CHARACTERISTICS

($T_J=25^{\circ}\text{C}$, unless otherwise specified) (Note1)

PARAMETER	TEST CONDITIONS	SYMBOL	MIN.	TYP.	MAX.	UNIT	
Quiescent Current	$V_{IN} = V_{OUT} + 1\text{V}$, $V_{\overline{\text{SHDN}}}=1.6\text{V}$, $I_{OUT} = 0\text{mA}$	I_Q		35	45	μA	
Standby Current	$V_{IN} = V_{OUT} + 1\text{V to } 8\text{V}$, $V_{\overline{\text{SHDN}}}=0.6\text{V}$, Output OFF	I_{STBY}			0.1	μA	
GND Pin Current	$I_{OUT} = 50\text{mA}$	I_{GND}		2.5	3.5	mA	
Continuous Output Current	$V_{IN} = V_{OUT} + 1\text{V to } 8\text{V}$	I_{OUT}			150	mA	
Output Current Limit	$V_{IN} = V_{OUT} + 1\text{V}$, $V_{OUT} = 0\text{V}$	I_{IL}	150	250		mA	
Output Voltage Tolerance	$V_{IN} = V_{OUT} + 1\text{V}$, no load	V_{OUT}	-2		2	%	
Temperature Coefficient		T_C		50	150	$\text{ppm}/^{\circ}\text{C}$	
Line Regulation	$V_{IN} = V_{OUT(\text{TYP})} + 1\text{V to } 8\text{V}$	ΔV_{LIR}		2	5	mV	
Load Regulation	$V_{IN} = 5\text{V}$, $I_{OUT} = 0.1\sim 150\text{mA}$	ΔV_{LOR}		0.005	0.01	%/mA	
Dropout Voltage	$I_{OUT} = 50\text{mA}$	V_{DROP}			90	160	mV
	$I_{OUT} = 100\text{mA}$				140	230	
	$I_{OUT} = 150\text{mA}$				200	350	
	$I_{OUT} = 150\text{mA}$, $V_{\text{out}} < 2.5\text{V}$				500	800	
Noise Bypass Terminal Voltage		V_{REF}		1.25		V	
Ripple Rejection	$f=1\text{KHz}$, Ripple=0.5V _{P-P} , $C_{\text{BP}} = 0.1\mu\text{F}$	RR		65		dB	
Output Noise	$C_{\text{BP}} = 0.1\mu\text{F}$, $f = 10\sim 100\text{KHz}$	e_n		25		μV_{rms}	
SHUTDOWN TERMINAL SPECIFICATIONS							
Shutdown Pin Current	$V_{\overline{\text{SHDN}}}=1.6\text{V}$	$I_{\overline{\text{SHDN}}}$			2	μA	
Shutdown Pin Voltage (ON)	Output ON	$V_{\overline{\text{SHDN}}}(\text{ON})$	1.6			V	
Shutdown Pin Voltage (OFF)	Output OFF	$V_{\overline{\text{SHDN}}}(\text{OFF})$			0.6	V	
Shutdown Exit Delay Time	$C_{\text{BP}} = 0.1\mu\text{F}$, $C_{\text{OUT}} = 1\mu\text{F}$, $I_{OUT}=30\text{mA}$	Δt		300		μs	

Note 1: Specifications are production tested at $T_A=25^{\circ}\text{C}$. Specifications over the -40°C to 85°C operating temperature range are assured by design, characterization and correlation with Statistical Quality Controls (SQC).

Note 2: The dropout voltage is defined as $V_{IN} - V_{OUT}$ when V_{OUT} is 1% below the value of V_{OUT} for $V_{IN} = V_{OUT} + 0.5\text{V}$. (Only applicable for $V_{OUT} = 2.5\text{V} \sim 5\text{V}$)

TYPICAL PERFORMANCE CHARACTERISTICS

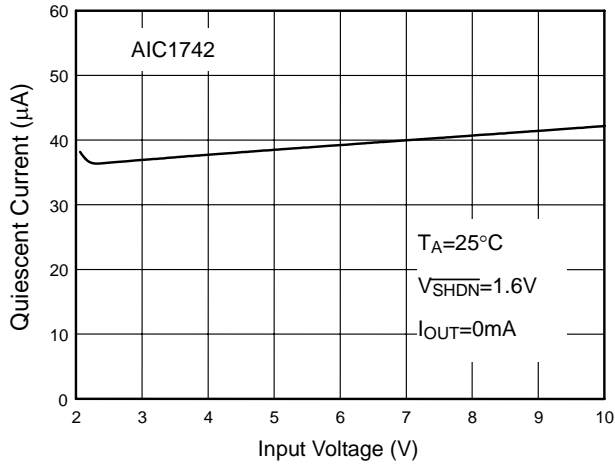

Fig. 1 Quiescent Current

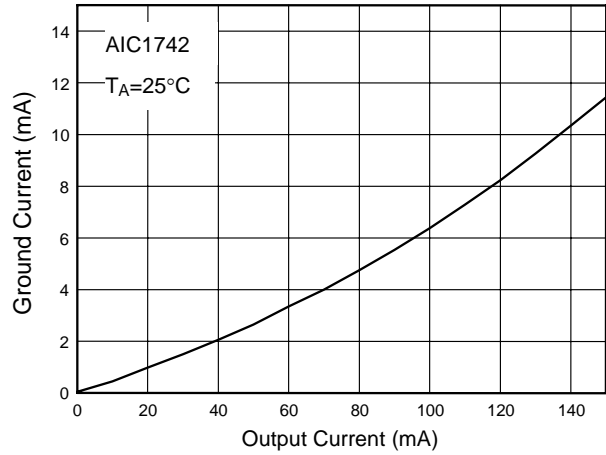

Fig. 2 Ground Current

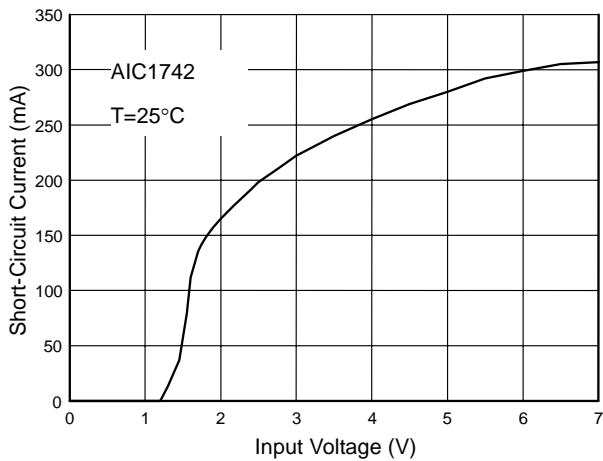

Fig. 3 Short-Circuit Current

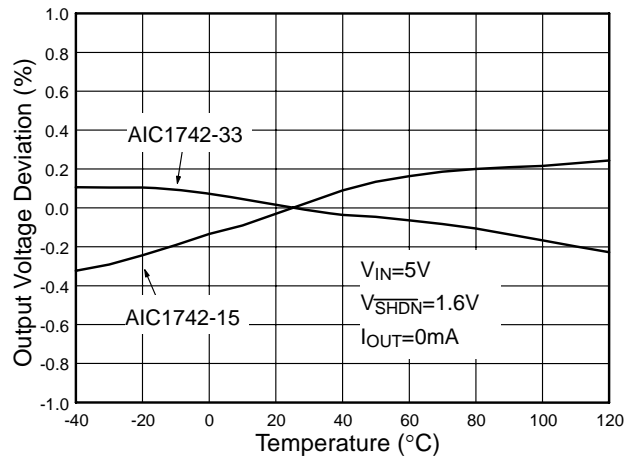

Fig. 4 Output Voltage

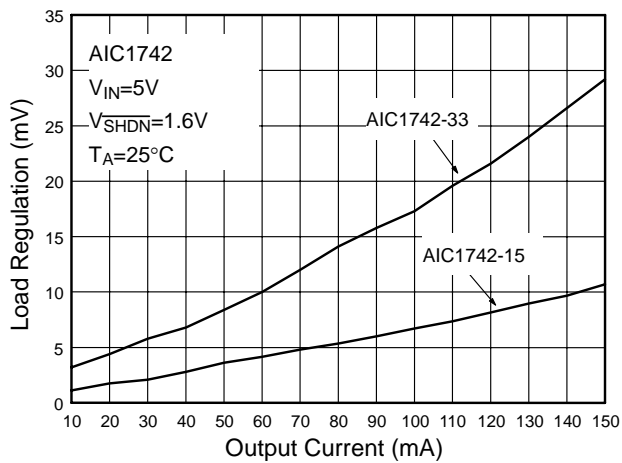

Fig. 5 Load Regulation

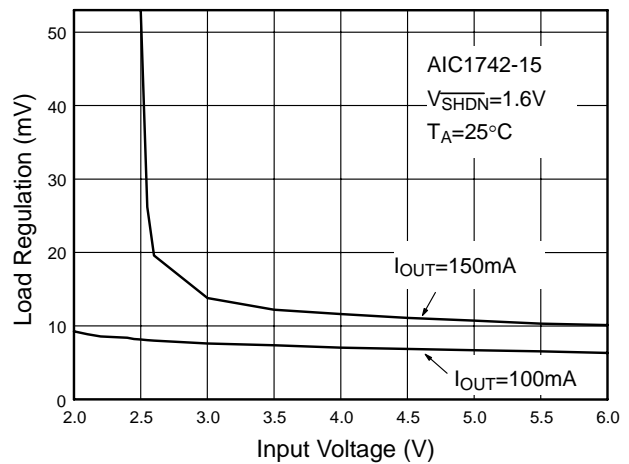

Fig. 6 Load Regulation

TYPICAL PERFORMANCE CHARACTERISTICS (Continued)

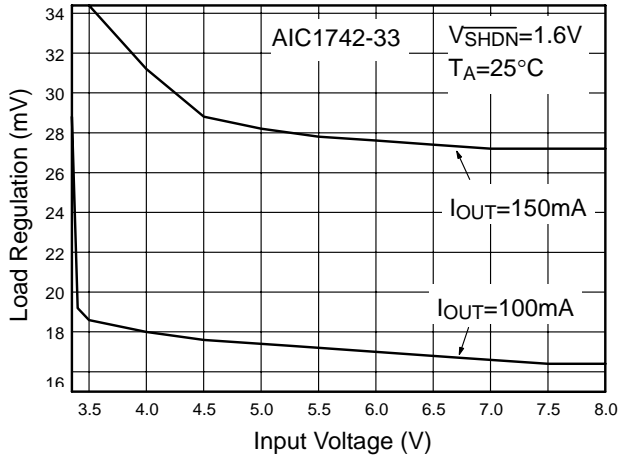

Fig. 7 Load Regulation

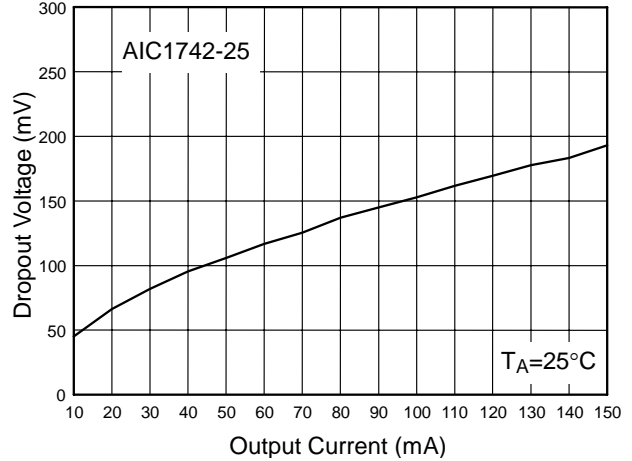

Fig. 8 Dropout Voltage

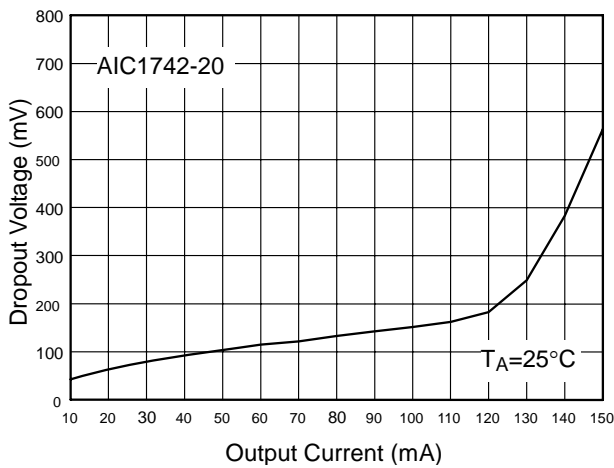

Fig. 9 Dropout Voltage

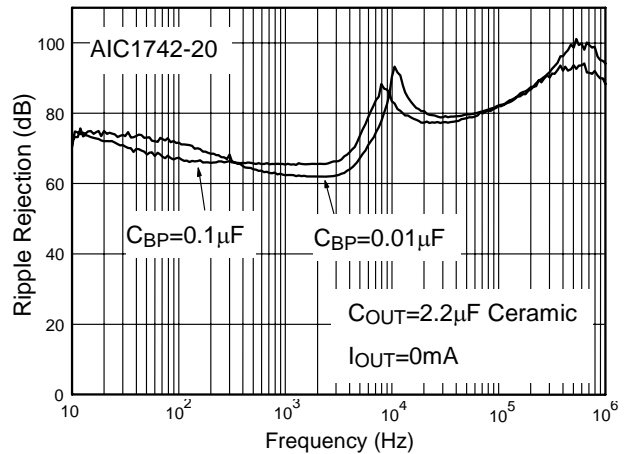

Fig. 10 Input Ripple Rejection

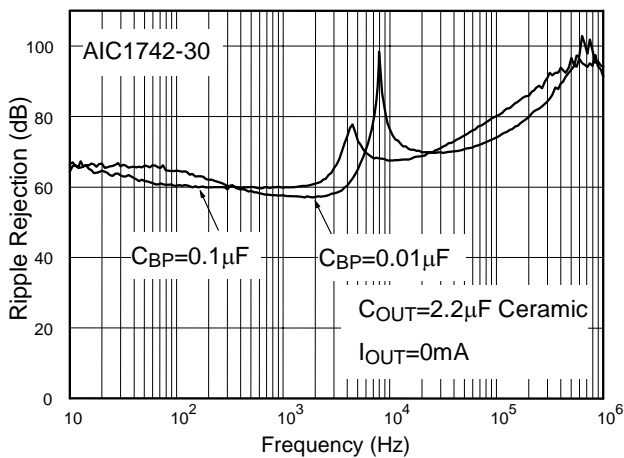

Fig. 11 Input Ripple Rejection

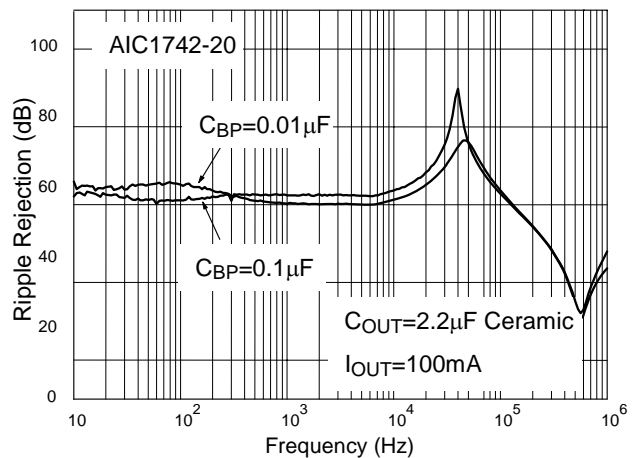

Fig. 12 Input Ripple Rejection

TYPICAL PERFORMANCE CHARACTERISTICS (Continued)

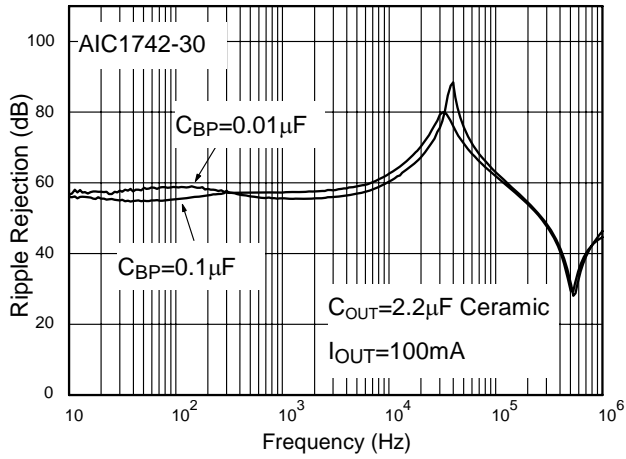

Fig. 13 Input Ripple Rejection

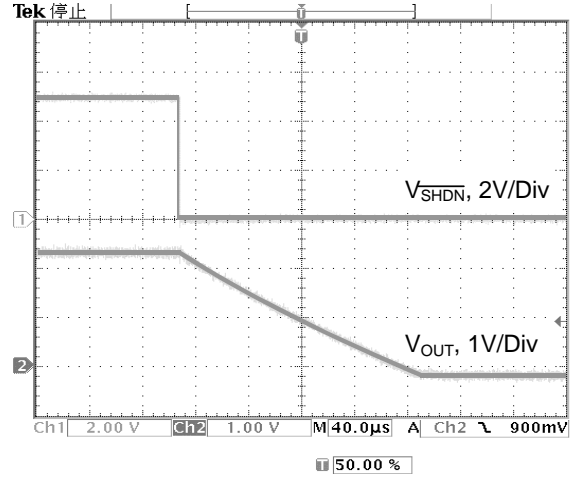

Fig. 14 Shutdown Delay

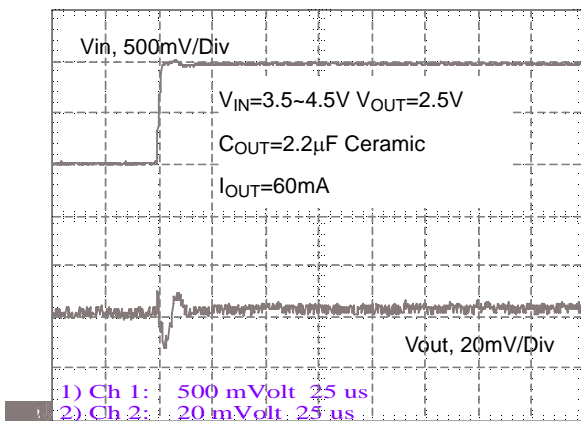

Fig. 15 Line Transient Response

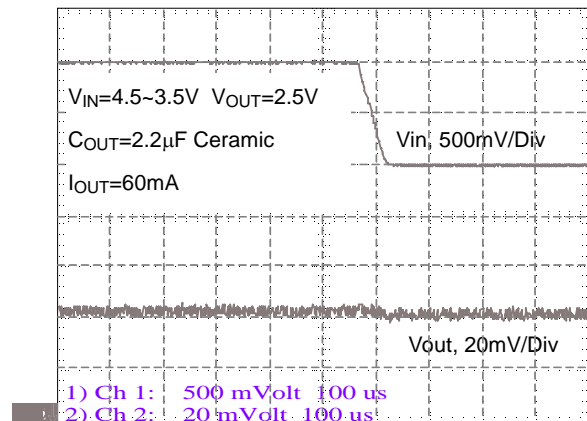

Fig. 16 Line Transient Response

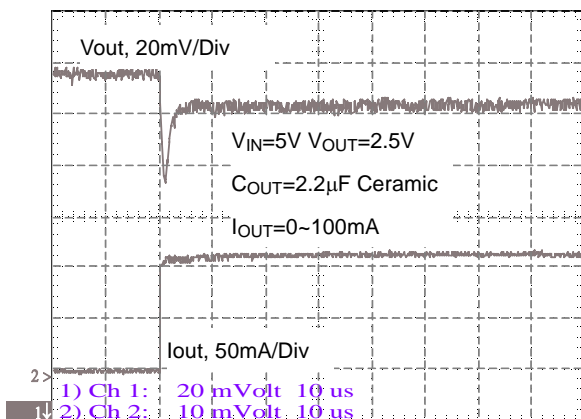

Fig. 17 Transient Response 2

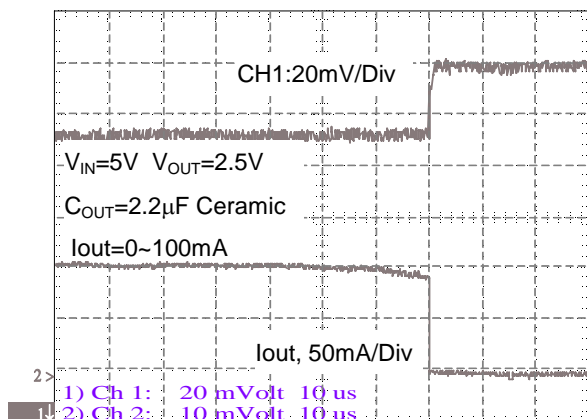

Fig. 18 Load Transient Response

TYPICAL PERFORMANCE CHARACTERISTICS (Continued)

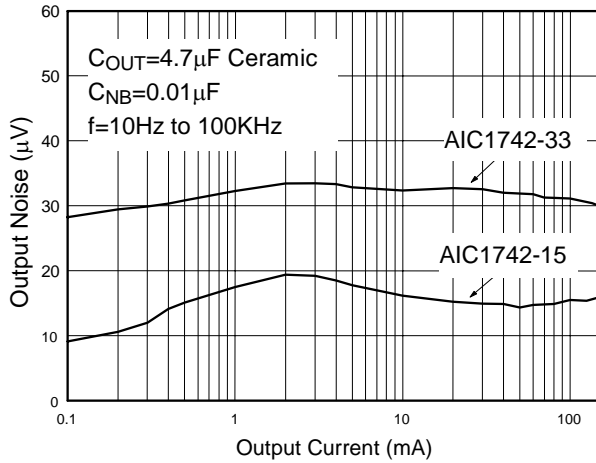
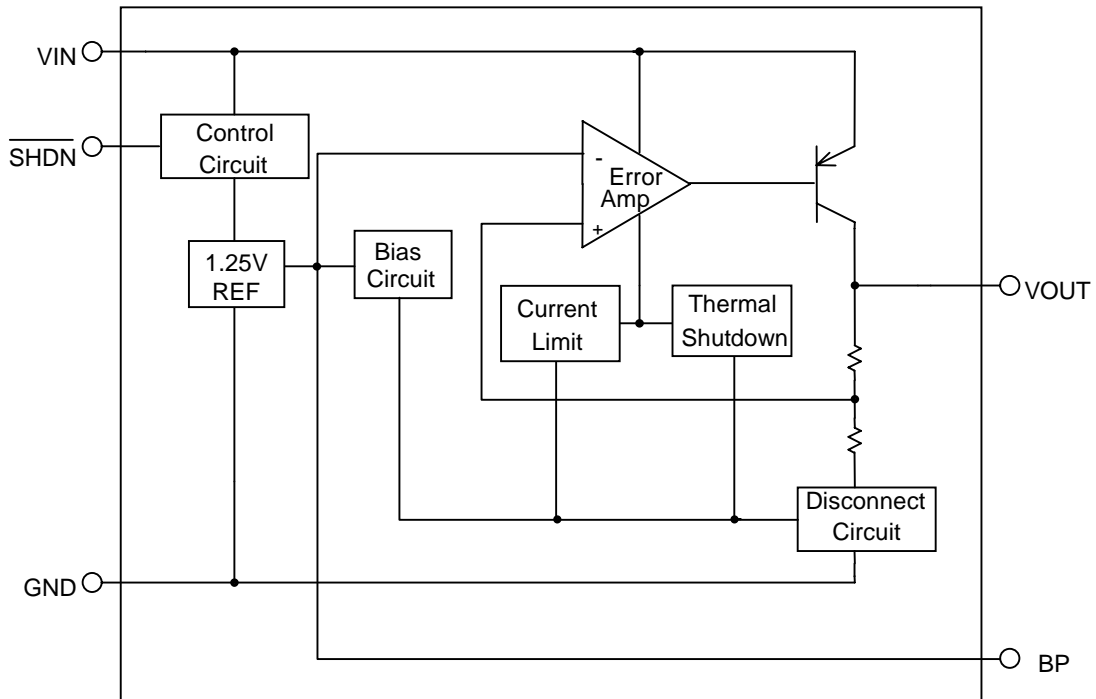

Fig. 19 Output Noise RMS

BLOCK DIAGRAM



PIN DESCRIPTIONS

- VIN PIN - Power supply input pin. Bypass with a 1µF capacitor to GND.
- GND PIN - Ground pin.
- SHDN PIN- Active-Low shutdown input pin.

- BP PIN - Noise bypass pin. An external bypass capacitor connecting to BP pin to reduce noises at the output.
- VOUT PIN - Output pin. Sources up to 150 mA.

■ DETAILED DESCRIPTION OF TECHNICAL TERMS

DROPOUT VOLTAGE (V_{DROP})

The dropout voltage is defined as the difference between the input voltage and output voltage at which the output voltage drops 100mV. Below this value, the output voltage will fall as the input voltage reduces. It depends on the load current and junction temperature.

LINE REGULATION

Line regulation is the ability of the regulator to maintain a constant output voltage as the input voltage changes. The line regulation is specified as the input voltage changes from $V_{IN} = V_{OUT} + 1V$ to $V_{IN} = 8V$ and $I_{OUT} = 1mA$.

LOAD REGULATION

Load regulation is the ability of the regulator to maintain a constant output voltage as the load current changes. A pulsed measurement with an input voltage set to $V_{IN} = V_{OUT} + V_{DROP}$ can minimize temperature effects. The load regulation is specified by the output current ranging from 0.1mA to 150mA.

QUIESCENT CURRENT (I_Q)

Quiescent current is the current flowing through ground pin with no output load.

GROUND CURRENT (I_{GND})

Ground current is the current flowing through the ground pin with output load.

STANDBY CURRENT (I_{STBY})

Standby current is the current flowing into the regulator when the output is shutdown by setting V_{SHDN} at 0V and V_{IN} at 8 V.

CURRENT LIMIT (I_{IL})

Current limiting of AIC1742 monitors and controls the maximum output current, in case of a shorted output. It protects device from the damage resulting from any unexpected current.

RIPPLE REJECTION (RR)

Ripple rejection is the ability of the regulator to reduce voltage ripple, which comes from input, at output terminal. It is specified with a signal of $0.5V_{P-P}$ at 1KHz frequency applying to input, output capacitor at $2.2\mu F$ as well as a noise bypass of $0.1\mu F$. Ripple rejection, expressed in dB, is the ratio of output ripple to input.

THERMAL PROTECTION

Thermal sensor protects device when the junction temperature exceeds $T_J = +155^\circ C$. It signals shutdown logic, turning off pass transistor and allowing IC to cool down. After the IC's junction temperature cools by $15^\circ C$, the thermal sensor will turn the pass transistor back on. Thermal protection is designed to protect the device in the event of fault conditions. For a continuous operation, do not exceed the absolute maximum junction-temperature rating of $T_J = 150^\circ C$, or damage may occur to the device.

■ APPLICATION INFORMATION

INPUT-OUTPUT CAPACITORS

Linear regulators require input and output capacitors to maintain stability. Input capacitor at $1\mu\text{F}$ with $1\mu\text{F}$ aluminum electrolytic or $2.2\mu\text{F}$ ceramic output capacitor is recommended. And it should be selected within the Equivalent Series Resistance (ESR) range as shown in the figure 20,21. ESR of ceramic capacitor is lower and its electrical characteristics (capacitance and ESR) vary widely over temperature. In general, tantalum or electric output capacitor is suggested for heavy load. Normally, the output capacitor should be $1\mu\text{F}$ (aluminum electrolytic) at least and rates for operating temperature range. Note that it's important to check selected manufactures electrical characteristics (capacitance and ESR) over temperature.

NOISE BYPASS CAPACITOR

$0.01\mu\text{F}$ bypass capacitor at BP pin reduces output voltage noise. And the BP pin has to connect a capacitor to GND.

POWER DISSIPATION

The maximum power dissipation of AIC1742 depends on the thermal resistance of its case and circuit board, the temperature difference between the die junction and ambient air, and the rate of airflow. The rate of temperature rise is greatly affected by the mounting pad configuration on the PCB, the board material, and the ambient temperature. When the IC mounting with good thermal conductivity is used, the junction temperature will be low even when large power dissipation applies.

The power dissipation across the device is

$$P = I_{\text{OUT}} (V_{\text{IN}} - V_{\text{OUT}}).$$

The maximum power dissipation is:

$$P_{\text{MAX}} = \frac{(T_{\text{J}} - T_{\text{A}})}{(R_{\theta\text{JB}} + R_{\theta\text{BA}})}$$

Where $T_{\text{J}} - T_{\text{A}}$ is the temperature difference between the die junction and the surrounding air, $R_{\theta\text{JB}}$ is the thermal resistance of the package, and $R_{\theta\text{BA}}$ is the thermal resistance through the PCB, copper traces, and other materials to the surrounding air.

As a general rule, the lower temperature is, the better reliability of the device is. So the PCB mounting pad should provide maximum thermal conductivity to maintain low device temperature.

GND pin performs a dual function of providing an electrical connection to ground and channeling heat away. Therefore, connecting the GND pin to ground with a large pad or ground plane would increase the power dissipation and reduce the device temperature.

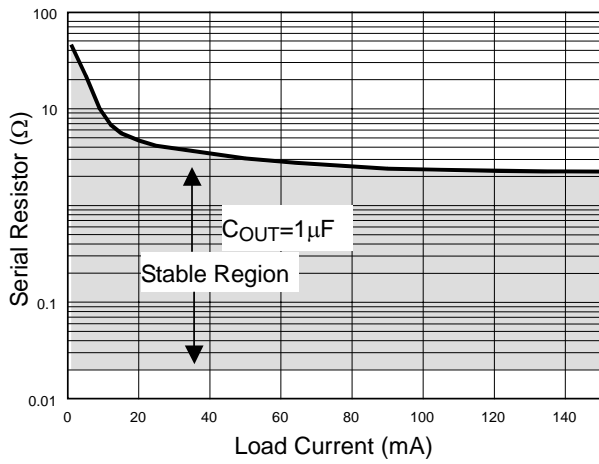

Fig. 20 Stable Region with extra Serial Resistor vs. Load Current

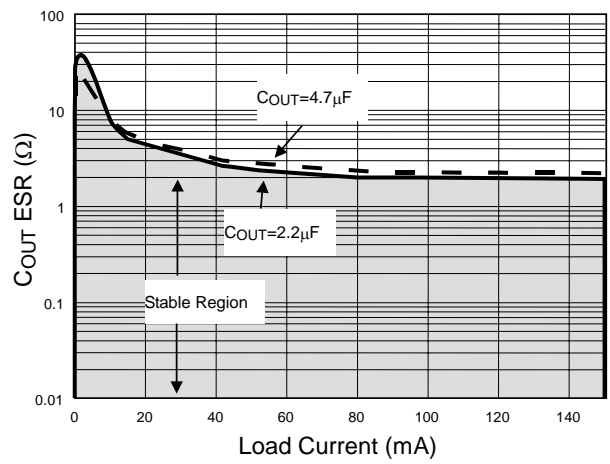
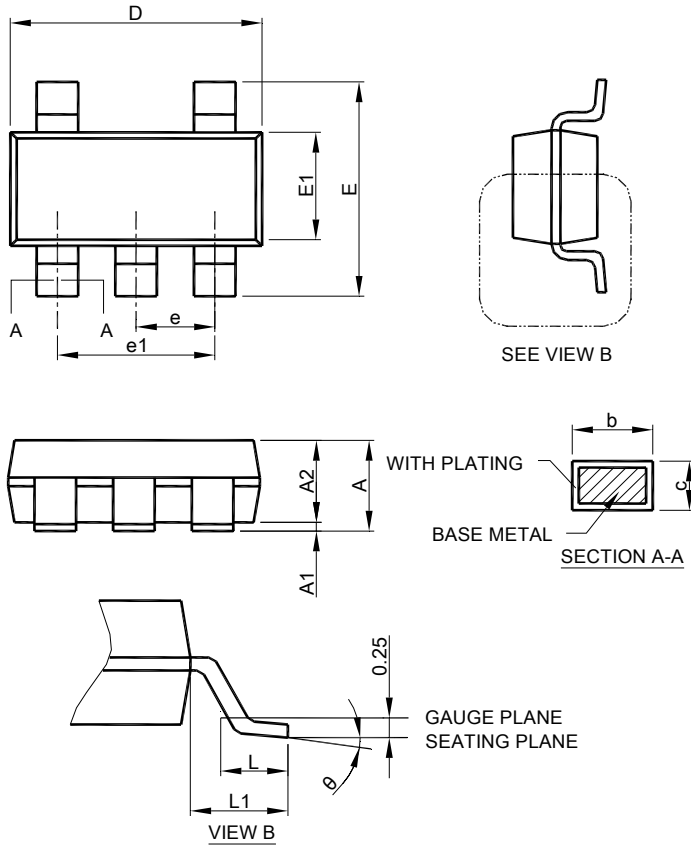

Fig. 21 Region of Stable C_{OUT} ESR vs. Load Current

■ PHYSICAL DIMENSIONS

- SOT-23-5 (unit: mm)



SYMBOL	SOT-23-5	
	MILLIMETERS	
	MIN.	MAX.
A	0.95	1.45
A1	0.05	0.15
A2	0.90	1.30
b	0.30	0.50
c	0.08	0.22
D	2.80	3.00
E	2.60	3.00
E1	1.50	1.70
e	0.95 BSC	
e1	1.90 BSC	
L	0.30	0.60
L1	0.60 REF	
q	0°	8°

- Note :
1. Refer to JEDEC MO-178AA.
 2. Dimension "D" does not include mold flash, protrusions or gate burrs. Mold flash, protrusion or gate burrs shall not exceed 10 mil per side.
 3. Dimension "E1" does not include inter-lead flash or protrusions.
 4. Controlling dimension is millimeter, converted inch dimensions are not necessarily exact.

Note:

Information provided by AIC is believed to be accurate and reliable. However, we cannot assume responsibility for use of any circuitry other than circuitry entirely embodied in an AIC product; nor for any infringement of patents or other rights of third parties that may result from its use. We reserve the right to change the circuitry and specifications without notice.

Life Support Policy: AIC does not authorize any AIC product for use in life support devices and/or systems. Life support devices or systems are devices or systems which, (i) are intended for surgical implant into the body or (ii) support or sustain life, and whose failure to perform, when properly used in accordance with instructions for use provided in the labeling, can be reasonably expected to result in a significant injury to the user.